

Autofile

every component needed for success



One of the greatest secrets of a highly successful service department can be found in the way they access and store their records. Speed and accuracy are crucial to maintaining efficiency with the help of color-coded labels that organize the service records into manageable groups. This helps reduce filing errors and accelerates file access.

That's why we created Autofile. Effectively combining the products we offer will allow you to keep a record of every customer's important sales documents, lease documents, warranty and delivery information. Easy access helps you to quickly respond to follow-up visits and other inquiries. This filing system also makes it easy to keep track of customers who lease vehicles in order to sell them new leases or inform them of their buy-out options on their existing lease.

But don't just take our word for it. Browse our extensive product line, make a few purchases, and see for yourself how the proper filing tools can streamline your business.

catalog CONTENTS

folders	4
jackets	4–5
vehicle make labels	6
year labels	7
month labels	7
numeric labels	8
alphabetic labels	9
name labels	10
name label protectors	10
solid color labels	11
key tags	12
window stock stickers	12
codeaprint.com	13
slanted shelving	14
straight shelving	14
stak-n-lok™ shelving	15
moveable shelving	15

serviceFOLDERS

These 14 pt. single-ply end-tab folders give you a place to store hard copies of warranty work, repairs, and maintenance records. Folders feature a full end-tab for easy VIN identification and printed placement lines to aid in applying our color-coded labels. 500 folders per carton.

EXTP14 – OUTSIDE

VEHICLE IDENTIFICATION NUMBER

WARRANTY/SERVICE DATE _____ YEAR _____ MAKE _____ MODEL _____

KEY NUMBERS NEW USED

IGNITION _____ TRUNK _____ COLOR CODE _____ OTHER _____

ORIGINAL OWNER

NAME _____

ADDRESS _____

CITY / STATE / ZIP _____

SECOND OWNER

NAME _____

ADDRESS _____

CITY / STATE / ZIP _____

THIRD OWNER

NAME _____

ADDRESS _____

CITY / STATE / ZIP _____

EXTENDED WARRANTY PURCHASED

WARRANTY ADJUSTMENT

AUTHORIZATION NUMBER _____

WORK PERFORMED _____

AUTHORIZED BY _____

AUTHORIZATION DATE _____

AUTHORIZATION TIME _____

CUSTOMER'S COST \$ _____

COMMENTS _____

EXTP14 – INSIDE

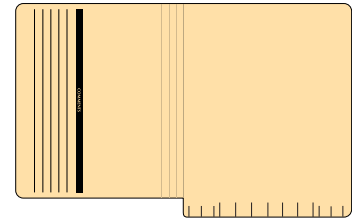

Overall Size:
9½" H x 12⅝" W

Front Size:
9½" H x 11¼" W

Weight:
46.75 lbs/ctn

EXT14 – OUTSIDE

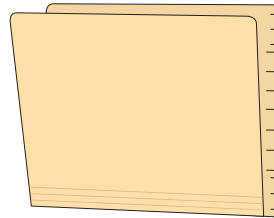

EXT14 – INSIDE

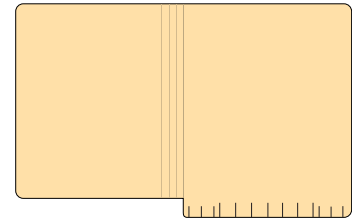

salesJACKETS

11 pt. sales jackets are made from heavy-duty stock for storing customer sales, lease, warranty, and delivery information. Use different colored jackets to distinguish between files. Closed on three sides to prevent materials from falling out. 500 sales jackets per carton.

Lateral Drawer Jackets – Includes Double-Ply Tab

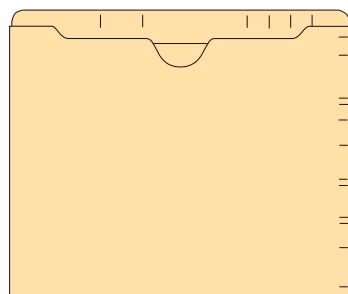

FP11

Overall Size:
9½" H x 11⅜" W

Weight:
40.5 lbs/ctn

FP11DKD

FP11DKG

FP11L

FP11DKB

FP11DKY

FP11CAN

End-Tab Shelf Jackets – Includes Single-Ply Tab

Model Year _____ Stock # _____

Model _____

Year _____ Date Sold _____ Address _____

Motor Serial # _____ City _____

Date Purchased _____ Invoice # _____

Name of Seller _____ Phone # _____

Address _____

City _____ Bill of Sale

State _____ Zip _____ Title

Title # _____ Odometer Certification

License # _____

Received Title _____

Signature of Purchaser _____

011-AJY

Overall Size:
9½" H x 12⅝" W

Weight:
49.15 lbs/ctn

011-AJOR

011-AJLV

011-AJGY

011-AJGN

011-AJBE

011-BAJY (BLANK)

filing JACKETs

Various 11 pt. filing jackets to meet all your needs.

FP12 – 9½" H x 12¼" W
Reinforced side seam, single-ply top

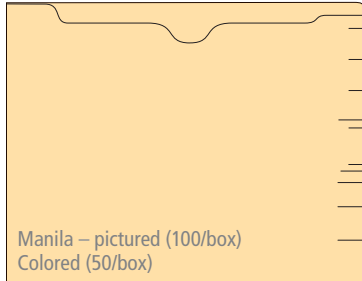

Manila – pictured (100/box)
Colored (50/box)

FP12DKD	FP12L	FP12DKG	FP12DKB
FP12CAN	FP12E	FP12DKH	FP12DKY

M11PK – 9½" H x 12¼" W
Colored border, double-ply top and side (100/box)

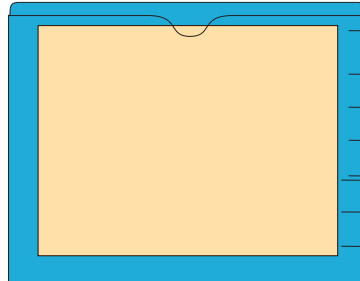

M11PKD	M11PKE	M11PKG	M11PKC	M11PKY
M11PKV	M11PKB (pictured)	M11PKH	M11PKI	M11PKO

MPX11 – 9½" H x 11¾" W (9" H front)
Double-ply top tab, ½" expansion (50/box)

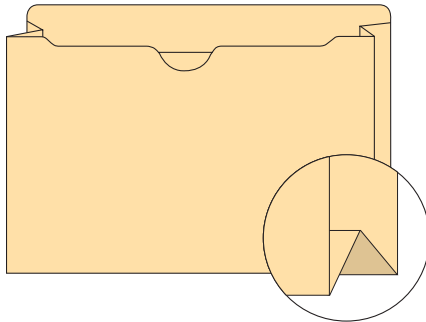

AC11 – 9½" H x 12¼" W
Diagonal cut front panel, double-ply end-tab, Manila (pictured) and Colored (100/box)

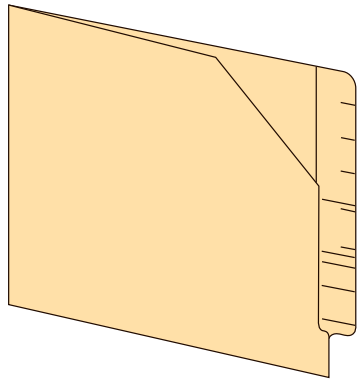

AC11D	AC11L
AC11CAN	AC11E
AC11DKG	AC11DKB
AC11DKH	AC11DKY

AC14 (not pictured) – 9½" H x 11¾" W
14 pt. Manila (50/box)

Economy File Envelopes – 8¾" H x 11¾" W
Perfect filing envelopes for lightly used files. Closed on three sides. Front is printed with spaces for name, home, and business phone numbers plus addresses. (100/box)

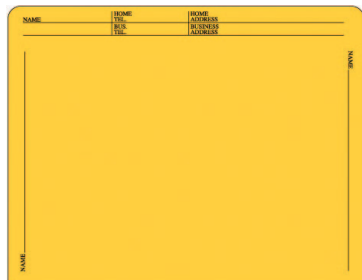













































1171SUN	1172OR	1173BR	1174GO	1175PY
1176COR	1177BE	1178Y (pictured)	1179OL	1180ST
1181LGN	1182WHT	1071K	1073GY	

28 lb. – All colors except 1071K and 1073GY
32 lb. – 1071K and 1073GY

vehiclemake LABELS

Quickly identify files for a specific vehicle make with these color-coded labels. Add a year label for even greater efficiency. 270 labels per RB Pkg.

				
RB PKG 622A	RB PKG 625A	RB PKG 630B	RB PKG 612B	RB PKG 602C
				
RB PKG 606C	RB PKG 619C	RB PKG 609D	RB PKG 615E	RB PKG 605F
				
RB PKG 607G	RB PKG 621G	RB PKG 617G	RB PKG 608H	RB PKG 644H
				
RB PKG 629H	RB PKG 637I	RB PKG 620I	RB PKG 633I	RB PKG 641J
				
RB PKG 614J	RB PKG 639K	RB PKG 628L	RB PKG 604L	RB PKG 611M
				
RB PKG 631M	RB PKG 603M	RB PKG 623M	RB PKG 636M	RB PKG 610N
				
RB PKG 601O	RB PKG 618P	RB PKG 613P	RB PKG 634P	RB PKG 642R
				
RB PKG 638S	RB PKG 627S	RB PKG 643S	RB PKG 632S	RB PKG 624S
				
RB PKG 616T	RB PKG 640U	RB PKG 626V	RB PKG 635V	

Finish:

Polylaminated

Label Size:

1 1/2" W x 3/4" H

Sheet Size:

5 3/4" W x 8 1/2" H

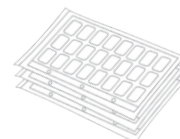

RB Pkg













yearLABELS

Year labels can be used to identify the year of a vehicle, last year of service, year vehicle was purchased, lease expiration, etc. They are color-coded and can help you identify and remove inactive files. Choose from 500 labels per roll or 270 labels per RB pkg.

 RB PKG 0402FGN ROLL 0702FGN	 RB PKG 0403R ROLL 0703R	 RB PKG 0404PRW ROLL 0704PRW	 RB PKG 0405ORW ROLL 0705ORW
 RB PKG 0406LBEW ROLL 0706LBEW	 RB PKG 0407YBK ROLL 0707YBK	 RB PKG 0408P ROLL 0708P	 RB PKG 0409RS ROLL 0709RS
 RB PKG 0410RBN ROLL 0710RBN	 RB PKG 0411RLV ROLL 0711RLV	 RB PKG 0412RYB ROLL 0712RYB	Finish: Polylaminated Label Size: 1½" W x ¾" H Sheet Size: 5¾" W x 8½" H

monthLABELS

Use month labels with year labels to highlight the last month of service on a vehicle or to identify the lease expiration date. Month labels also aid with removing inactive records. Choose from 500 labels per roll or 270 labels per RB pkg.

 RB PKG 15031J ROLL 15061J	 RB PKG 15032F ROLL 15062F	 RB PKG 15033M ROLL 15063M	 RB PKG 15034A ROLL 15064A
 RB PKG 15035M ROLL 15065M	 RB PKG 15036J ROLL 15066J	 RB PKG 15037J ROLL 15067J	 RB PKG 15038A ROLL 15068A
 RB PKG 15039S ROLL 15069S	 RB PKG 15040O ROLL 15070O	 RB PKG 15041N ROLL 15071N	 RB PKG 15042D ROLL 15072D

Finish: Polylaminated
Label Size: 1½" W x ¾" H
Sheet Size: 5¾" W x 8½" H

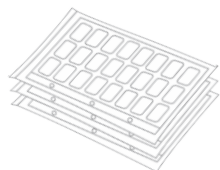

Complete Set - Pkgs (Month Labels)
Includes: 12 Pkgs
(270 labels per RB Pkg)
ITEM NO. 15059SET



Complete Set - Rolls (Month Labels)
Includes: Display box and 12 Rolls
(500 labels per Roll)
ITEM NO. 15089SET

year & month

numeric LABELS

Color-code the last six digits of the VIN to quickly identify the file for a particular vehicle.
Choose from 500 labels per roll or 240 labels per RB Pkg.



RB PKG
ROLL 5830OR*
5860OR*

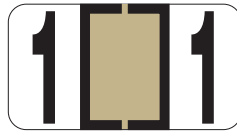

RB PKG
ROLL 5831GD
5861GD



RB PKG
ROLL 5832BE
5862BE



RB PKG
ROLL 5833Y
5863Y



RB PKG
ROLL 5834BK
5864BK



RB PKG
ROLL 5835LGN*
5865LGN*



RB PKG
ROLL 5836R
5866R



RB PKG
ROLL 5837LBE
5867LBE

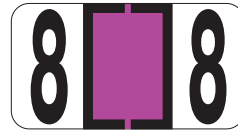

RB PKG
ROLL 5838P
5868P



RB PKG
ROLL 5839DGN*
5869DGN*

Finish:
Polylaminated
Label Size:
1 5/8" W x 7/8" H
Sheet Size:
5 3/4" W x 8 1/2" H

*Alternate colors are available for 0, 5, and 9 below.
Check your color sequence before ordering.



RB PKG
ROLL 5830-200LG
5860-200LG



RB PKG
ROLL 5835-200OR
5865-200OR

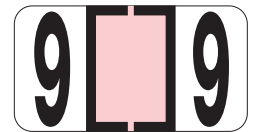

RB PKG
ROLL 5839-200PK
5869-200PK

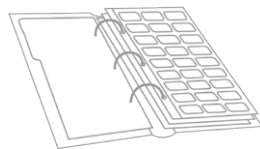

Starter Kit – Pkgs

Includes: 3-ring binder with indexes
and 10 Pkgs (240 labels per RB Pkg)
ITEM NO. 5857SK & 5857-200SK*

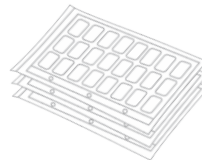

Complete Set – Pkgs

Includes: 10 Pkgs
(240 labels per RB Pkg)
ITEM NO. 5859SET & 5859-200SET*

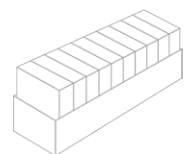

Complete Set – Rolls

Includes: Display box and 10 Rolls
(500 labels per Roll)
ITEM NO. 5889SET & 5889-200SET*

alphabetic LABELS

Alphabetic labels are used for color-coding customer's last names. They help easily identify and prevent misfiles. Choose from 500 labels per roll or 270 labels per RB Pkg.

				
RB PKG 3830A ROLL 3860A	RB PKG 3831B ROLL 3861B	RB PKG 3832C ROLL 3862C	RB PKG 3833D ROLL 3863D	RB PKG 3834E ROLL 3864E
				
RB PKG 3835F ROLL 3865F	RB PKG 3836G ROLL 3866G	RB PKG 3837H ROLL 3867H	RB PKG 3838I ROLL 3868I	RB PKG 3839J ROLL 3869J
				
RB PKG 3840K ROLL 3870K	RB PKG 3841L ROLL 3871L	RB PKG 3842M ROLL 3872M	RB PKG 3843N ROLL 3873N	RB PKG 3844O ROLL 3874O
				
RB PKG 3845P ROLL 3875P	RB PKG 3846Q ROLL 3876Q	RB PKG 3847R ROLL 3877R	RB PKG 3848S ROLL 3878S	RB PKG 3849T ROLL 3879T
				
RB PKG 3850U ROLL 3880U	RB PKG 3851V ROLL 3881V	RB PKG 3852W ROLL 3882W	RB PKG 3853X ROLL 3883X	RB PKG 3854Y ROLL 3884Y
				
RB PKG 3855Z ROLL 3885Z	RB PKG 3856MC ROLL 3886MC			

Finish:
Polylaminated

Label Size:
1½" W x ¾" H

Sheet Size:
5⅞" W x 8½" H

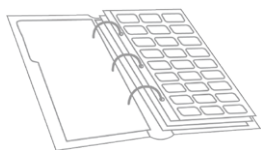

Starter Set – Pkgs

Includes: 3-ring binder with indexes
Sheets per Letter: A-16, B-6, C-7, D-4, E-11,
F-3, G-3, H-7, I-7, J-2, K-3, L-5, M-5, N-2, O-12,
P-4, Q-1, R-8, S-6, T-4, U-5, V-1, W-4, X-1, Y-1,
Z-1, MC-1 ITEM NO. 3857SK



Complete Set – Pkgs

Includes: 27 Pkgs
(270 labels per RB Pkg)
ITEM NO. 3859SET

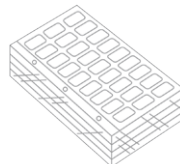

Refill Kit – Pkgs

Includes: Same number of
sheets per letter as starter kit
ITEM NO. 3858RK

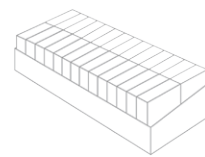

Complete Set – Rolls

Includes: Display box and 27 Rolls
(500 labels per Roll)
ITEM NO. 3889SET

Blank labels for use on a laser printer, typewriter, or pin-fed printer.

Laser Name Labels

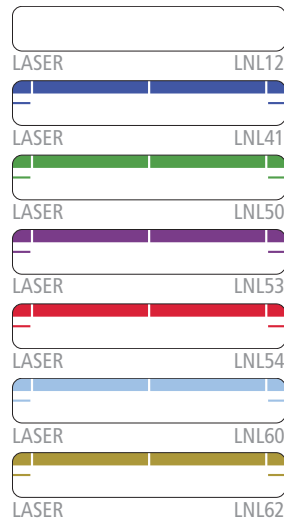

Description:

750 labels per pkg,
30 labels per sheet,
25 sheets per pkg

Label Size:

3⁷/₁₆" W x ⁹/₁₆" H

Sheet Size:

8¹/₂" W x 11" H

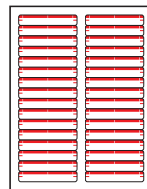

LASER SHEET

Continuous Name Labels

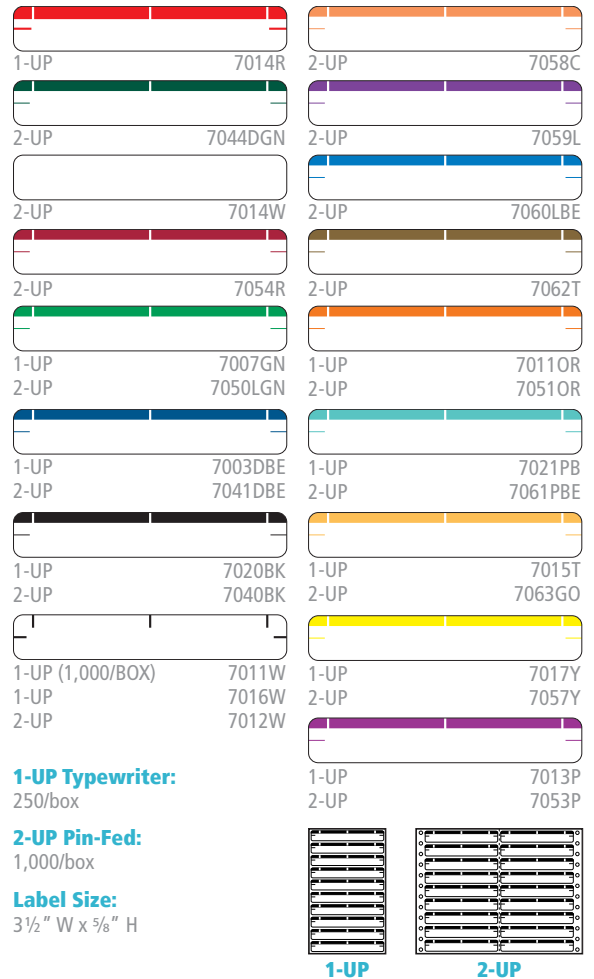

1-UP

2-UP

namelabelPROTECTORS

Protect name labels from smudges, dirt, and peeling. Choose from two styles to prevent misfiles. 500 per box.

Solid Color Size: 3¹/₂" W x 1³/₄" H (before folding)

CLEAR	7500TP
BLUE	7501BE
GREEN	7507GN
RED	7514R
YELLOW	7517Y



Color Stripe Size: 3¹/₂" W x 2" H (before folding)



CLEAR	7400TP
BLUE	7401BE
GREEN	7407GN
RED	7414R
YELLOW	7417Y

solidcolorLABELS

Use these water-resistant, durable labels for anything you like. You can design your own color-coding system, or even print your own custom messages using your laser printer. 500 labels per roll.



Roll 6060BK



Roll 6062BN

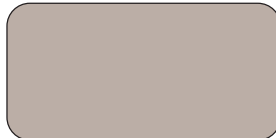

Roll 6066GY



Roll 6070LGN



Roll 6071OR



Roll 6072PK



Roll 6073P



Roll 6076W



Roll 6078TGY



Roll 6079GD



Roll 6080FOR



Roll 6081TGDY



Roll 6082LBE

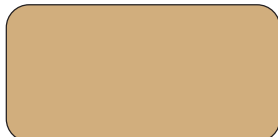

Roll 6083T



Roll 6074R
Rngbk 6044R*



Roll 6077Y
Rngbk 6047Y*



Roll 6061BE
Rngbk 6031BE*



Roll 6064DGN
Rngbk 6034DGN*

Roll:
500/roll

Individual Colors:
500 labels/box

Complete Set (6089SET):
18 rolls, 9,000 labels

Label Size and Finish:
1½" W x ¾" H, Poly laminated

***Rngbk:**
27 labels/sheet

Individual Colors:
270 labels

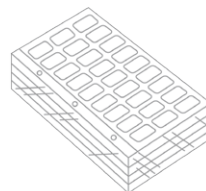

solidcolor

keyTAGS

Our key tags have a tear-proof, self-laminating cover that keeps information legible by protecting from dirt, grease, and moisture. Write on them using any pen or marker, and simply fold to laminate. Key rings are included. They are easy to use and extremely durable!



Description:
250/box

Size:
3" W x 3" H open,
1 1/4" W x 3" H folded

WHITE	AUT-AT250W
BLUE	AUT-AT250B
GREEN	AUT-AT250G
RED	AUT-AT250R
YELLOW	AUT-AT250Y

windowstockSTICKERS

These stock stickers are the most widely used by both new and used car dealers. Large spaces give you plenty of room to write information, and the clear plastic film with strong adhesive securely seals the sticker to the windshield. Use a different color for each model, year, month, or whatever system works best for you.

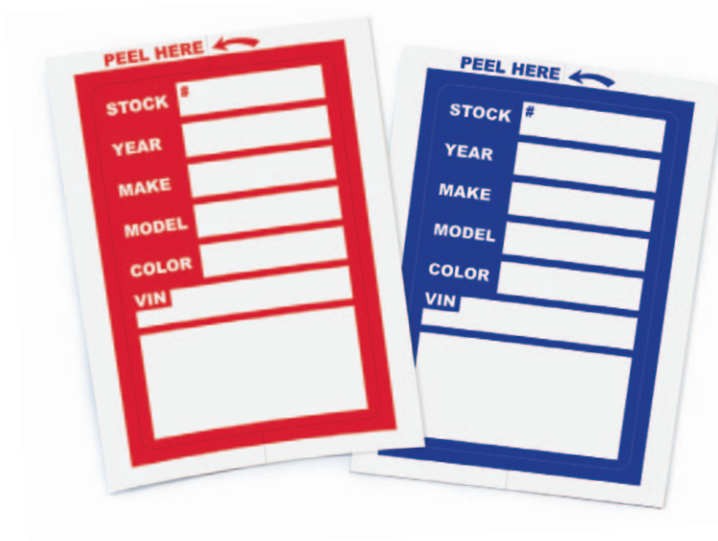

Description:
100/pkg

Label Size:
3" W x 4" H

BLUE	AUT-WSS100B
RED	AUT-WSS100R

codeaprint.COM

Codeaprint.com puts you in charge of file-labeling systems from your very own desktop. Because it's web-based, there's no specialized label-creation software to install. You don't need to worry about sensitive and confidential data leaving your computer. You can administer and control account access, and you're able to have an unlimited number of simultaneous users from as many computers as you need.

With codeaprint.com, you have the ability to print brilliant color-coded labels on-demand, complete with individualized bar codes and graphics. Match your existing systems, or customize with our help, then print on your laser or inkjet printer. It's as easy as 1-2-3!



1 Choose your label design.

We have a wide selection of pre-made label designs that you can browse. Otherwise, give us a call, and we will create a customized design just for you.

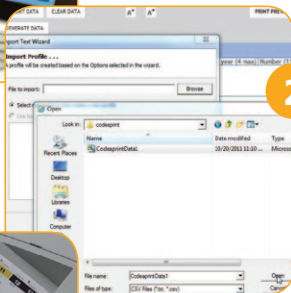

2 Enter or import your data.

Once you have chosen your design, use our easy program to input your data. Whether you type the information manually or upload a spreadsheet, you'll be able to preview and edit the results to ensure they are accurate and to your liking.



3 Print and affix your labels.

Using your desktop printer and the adhesive paper stock we've provided, you can print your labels at your convenience. Adhere to your folders, and you're done!

STRAIGHT SHELVING

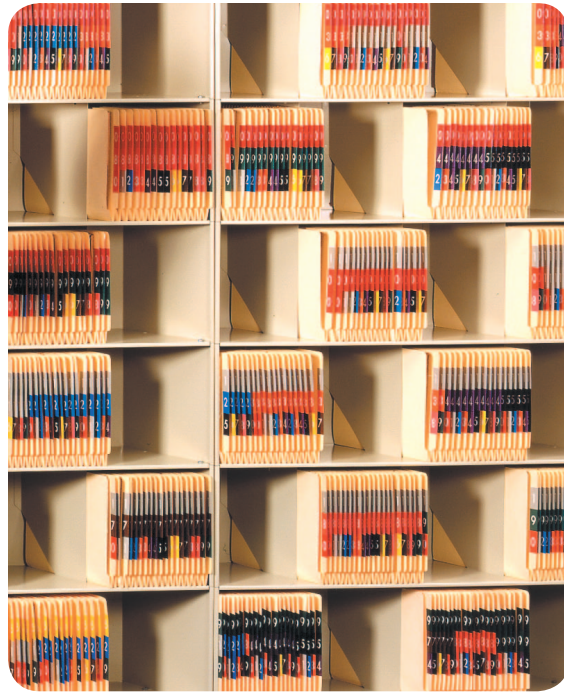

slantedSHELVING

The 55-degree angled design of these shelves allows the end tab of each folder to extend past the folder in front of it for error-free filing and fast retrieval. Slanted tiers also save valuable floor space by protruding less into a room. Additional tiers may be added as your dealership grows. Constructed from heavy-duty 18-gauge steel.

SIZE	TIERS	ITEM NO.
36"	6	9506SFS
36"	7	9507SFS
36"	8	9508SFS
48"	6	D9806SL
48"	7	D9807SL
48"	8	D9808SL

PUTTY LT. GRAY



straightSHELVING

Our straight shelf tiers can be stacked up to eight levels high to create custom solutions for unique storage needs. All tiers feature welded dividers to keep files upright. Maximize your storage capacity using the minimum amount of space. Additional tiers may be added at any time. Constructed from heavy-duty 18-gauge steel.

SIZE	TIERS	ITEM NO.
36"	6	9006FS
36"	7	9007FS
36"	8	9008FS
48"	6	D98016ST
48"	7	D98017ST
48"	8	D98018ST

PUTTY LT. GRAY

Please allow 1–2 weeks for delivery for both slanted and straight shelving. Both styles of shelving can be configured into moveable track systems – see next page.

stak-n-lokSHELVING

Stak-N-Lok™ shelving features locking doors for added security and privacy. One key conveniently locks all doors simultaneously, and the modular design allows you to add additional tiers to maximize space.

SIZE	TIERS	ITEM NO.
36"	6	SL366
36"	7	SL367
42"	6	SL426
42"	7	SL427

BONE WHITE LT. GRAY

Flip-Up Doors

Fully retractable doors store out of the way for easy file retrieval and replacement.

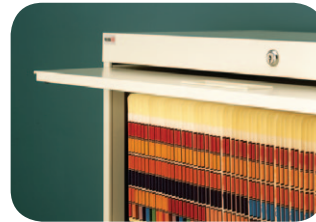

Please allow 2-3 weeks for delivery.

moveableSHELVING

Save even more space by converting your stationary shelving into moveable shelving with a track system. Low-profile track is placed directly in front of your wall-mounted row of stationary shelving, and an additional row of shelving is placed on a carriage that moves from side to side with a simple push of the hand. Track systems include: leveling track, anti-tip hardware, and heavy-duty carriages to ensure smooth rolling movement. Shelving is sold separately. Additional track may be added at any time to accommodate future storage requirements.

SIZE	STYLE	WIDTH	ITEM NO.
36"	Slanted	89"	5HDT2X1-SL36
36"	Straight	76"	5HDT2X1-ST36
48"	Slanted	113"	5HDT2X1-SL48
48"	Straight	100"	5HDT2X1-ST48

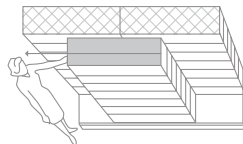

SIZE	STYLE	WIDTH	ITEM NO.
36"	Slanted	125"	5HDT3X2-SL36
36"	Straight	112"	5HDT3X2-ST36
48"	Slanted	161"	5HDT3X2-SL48
48"	Straight	148"	5HDT3X2-ST48

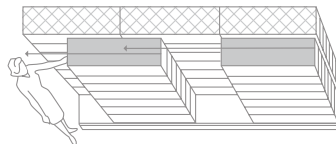

SIZE	STYLE	WIDTH	ITEM NO.
36"	Slanted	161"	5HDT4X3-SL36
36"	Straight	148"	5HDT4X3-ST36
48"	Slanted	209"	5HDT4X3-SL48
48"	Straight	196"	5HDT4X3-ST48

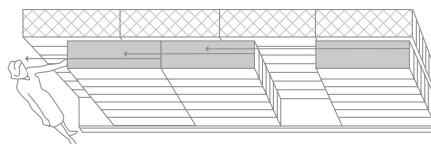

5-Unit Track System,
pictured with Stak-N-Lok™ (above)

3-Unit Track System (top)

Includes track for 2 stationary back units and 1 sliding front unit.

5-Unit Track System (middle)

Includes track for 3 stationary back units and 2 sliding front units.

7-Unit Track System (bottom)

Includes track for 4 stationary back units and 3 sliding front units.

Track systems increase overall shelving height by 4". Width includes 2" of over-travel at each end. Item numbers above depict 5-shelf-high units. 6- and 7-shelf-high units are also available. Please allow 3-4 weeks for delivery.